

Moveo Explorer
BY APDM

USER GUIDE

V2R
Version 2
April, 2019

WELCOME

TO Moveo Explorer









Using APDM's advanced wearable sensors, Moveo Explorer makes it easy to collect, analyze, and store kinematic data. Attach sensors to your subject, and instruct them to perform a task. A report is then automatically generated featuring joint angles, spatiotemporal gait and balance metrics, and raw data.

web: www.apdm.com

support & FAQ: community.apdm.com

sales: sales@apdm.com

CONTENTS

	INFORMATION	4		TIPS	38
	PARTS	10		TROUBLESHOOTING	40
	HARDWARE SETUP	16		SPECIFICATIONS	42
	MOVEO EXPLORER INSTALLATION	18		APPENDIX	44
	USING YOUR SYSTEM	20			

INFORMATION

i



Information about Opal V2R System

Intended Use Statement

The Opal V2R is a small worn monitor designed for documenting physical movement associated with applications in research and engineering. The Opal V2R can be used in any instance where quantifiable analysis of physical motion is desirable. Intended uses include motion detection, quantification of motion, quantification of movement, and quantification of human movement. Application uses include motion research, biomechanics, sports, fitness, and animation.

Opal V2R System Description

The Opal V2R System (“Opal System”) is a research-grade system comprised of one or more Opal V2R (“Opal”) wearable sensors, a Docking Station to recharge the Opal’s battery and transfer the raw sensor data logged to a computer, an Access Point to enable wireless streaming, adjustable straps for a variety of body locations, and Opal application software (Motion Studio, Moveo Explorer, or Moveo Explorer) that provides functionality for 1) configuring for 1) configuring the Opals, 2) collecting and storing Opal data, 3) analyzing and visualizing the collected data, and 4) exporting the data in various formats.

Contraindications

Do not apply Opals or the Opal straps to broken or otherwise non-intact skin. Opals and straps should not be used in conjunction with an MRI. Not a medical device. Medical uses require APDM’s Opal V2C System (FDA Class II Medical Device, CE Class I Medical Device; Rx Only).

Warnings and Precautions

The Moveo Explorer system Opal is a Type B Applied Part, i.e., a part of the system which comes into contact with the patient. The Moveo Explorer system Docking Station, Access Point, USB cables, and Docking Station power supply are not applied parts, and are not intended to come into contact with the subject. Opals should be cleaned in between subjects. See Tips section on page 35 for cleaning directions.

Do not open any Moveo Explorer hardware enclosures; there are no user serviceable parts inside. The Opals contain a rechargeable lithium ion battery which is not intended to be replaced by the user.

The Moveo Explorer Docking Station should only be powered by the provided 12V 2A center positive power adapter. Do not use other power adapters with the Docking Station.

The Moveo Explorer Docking Station has a spare USB Type A port. Only attach USB peripherals and cables that comply with the USB 2.1 specification. The Moveo Explorer system can only be connected to a host computer via the USB Micro-B connector.



The Opal wearable sensor may become warm during use and rise as much as 5 °C (9 °F) above ambient temperature. At the Opal's maximum operational temperature of 50 °C (122 °F), the Opal could reach 55 °C (131 °F). Discontinue use if wearing the sensor becomes uncomfortable.

The Moveo Explorer system is designed to be stored and transported in a standard indoor environment: a temperature of +10° C (50 °F) without relative humidity control and +50° C (122 °F) at relative humidity up to 93% non-condensing.

The Opals are designed to be operated in either an indoor or outdoor environment, with an operating temperature of -10 to +50 °C (14 to 122 °F), 0 to 100% relative humidity, and an atmospheric pressure of 64.4 to 106.6 kPa. Opals are rated water resistant up to IP64, but are not waterproof. Do not submerge Opals in water.

The Access Point and Docking Station are designed to be stored, operated and transported in a standard indoor environment: a temperature of 0 to 30 °C (32 to 86°F), 0 to 100% relative humidity, and an atmospheric pressure of 80 to 106.6 kPa (at an altitude of less than 2000 m). The Access Point and Docking Station are not water resistant or waterproof.

Do not unplug the Access Point when in use during testing; this may result in lost data. If using a laptop, always make sure that your laptop is plugged into a power outlet when testing during test mode. A low battery during a test session may cause the test data to be lost. It is recommended that you backup your Moveo Explorer database before upgrading or uninstalling the software.

You must dispose of this product properly according to local laws and regulations. Because this product contains electronic components, it must be disposed of separately from household waste. When this product reaches its end of life, contact local authorities to learn about disposal and recycling options, or simply return it to APDM. For more information, please visit community.apdm.com.

This equipment has been tested and found to comply with the limits for medical devices to the IEC 60601-1-2 standard. These limits are designed to provide reasonable protection against harmful interference in a typical medical installation. This equipment generates, uses and can radiate radio frequency energy and, if not installed and used in accordance with the instructions, may cause harmful interference with other devices in the vicinity. However, there is no guarantee that interference will not occur in a particular installation. If this equipment does cause harmful interference with other devices, which can be determined by turning the equipment off and on, the user is encouraged to try to correct the interference by one or more of the following measures:

- Configure the system to use a different radio frequency.
- Reorient or relocate the receiving device.
- Increase the separation between the equipment.
- Connect the equipment into an outlet on a circuit different from that to which the other device(s) are connected.
- Consult the manufacturer or field service technician for help.



Information Security for Computers running Moveo Explorer

The Moveo Explorer database may contain private or personal Protected Health Information (PHI). While Moveo Explorer accommodates the need to protect PHI, the database itself is not secured or encrypted by Moveo Explorer. Instead, you should secure access to the database using your operating system's built in security features. Always follow information security best practices on the Moveo Explorer computer, including:

- Use separate user and admin accounts
- Use strong passwords
- Lock the computer after a few minutes of inactivity
- Control physical access to your computer
- Keep your operating system and Moveo Explorer software up-to-date
- Back up your computer regularly and store your backups securely
- Use your operating system's built-in strong disk-level encryption

If your Moveo Explorer system is online, use internet security software to prevent malware infections. Moveo Explorer uses SSL to secure any communication with APDM servers that might contain personal information, and no PHI is collected without your consent. Any information on APDM servers is securely maintained.



Compliance Information

FCC

This device complies with part 15 of the FCC Rules. Operation is subject to the following two conditions:

1. This device may not cause harmful interference.
2. This device must accept any interference received, including interference that may cause undesired operation.

Changes or modifications not expressly approved by APDM could void the user's authority to operate the equipment.
To access FCC and IC information on the APDM Opal and Access Point - Press Button 2 twice from the home screen.

Industry Canada (IC)

This device complies with Industry Canada license-exempt RSS standard(s). Operation is subject to the following two conditions: (1) this device may not cause interference, and (2) this device must accept any interference, including interference that may cause undesired operation of the device.

Le présent appareil est conforme aux CNR d'Industrie Canadienne applicables aux appareils radio exempts de licence. L'exploitation est autorisée aux deux conditions suivantes : (1) l'appareil ne doit pas produire d'interférence, et (2) l'utilisateur de l'appareil doit accepter toute interférence subie, même si l'interférence est susceptible d'en compromettre le fonctionnement.

WEEE Directive Statement for the European Union

In common with all Electronic and Electrical products, APDM equipment should not be disposed of in household waste.

Alternative arrangements may apply in other jurisdictions.

FCC ID: 2AHZD-OPAL

IC: 21349-OPAL

Model: Opal









FCC ID: 2AHZD-AP

IC: 21349-AP

Model: AP



Symbols

	Serial Number
 —	Not for General Waste
	FCC Compliance
	Type B Applied Part
	Direct Current
	Refer to Instruction Manual/Booklet
IP64 I	Ingress Protection Rating
	Manufacturer
	European Union (EU) Mark

PARTS



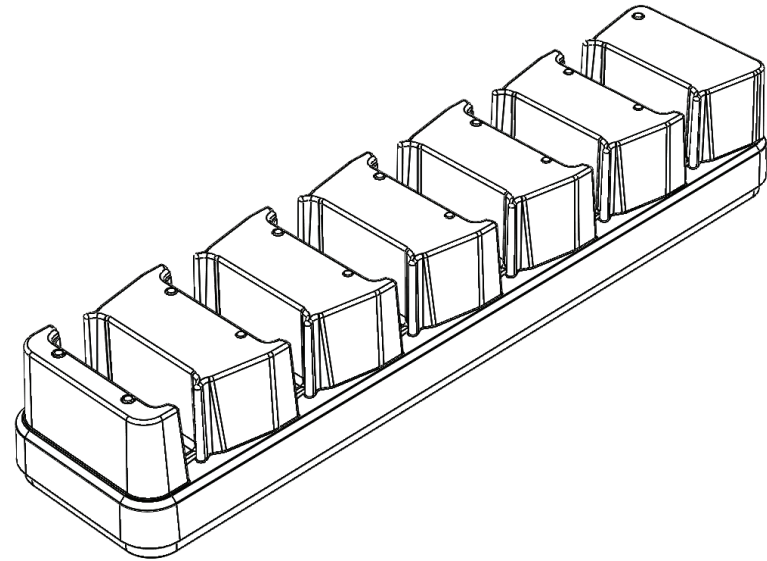
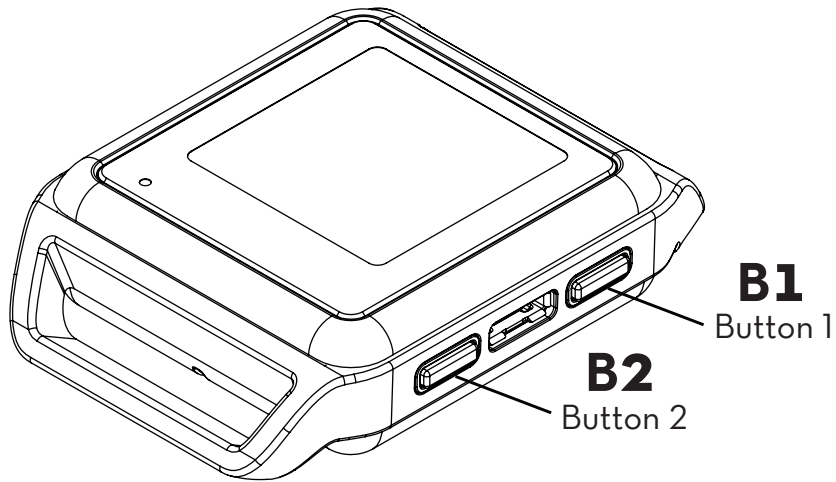

OPALS

The Opal sensors precisely record movement with triaxial accelerometers, gyroscopes, and magnetometers. Depending on your package, you may have up to 15 Opals.

DOCKING STATION

The Docking Station is used to charge and configure the Opal sensors. Depending on your package, you may have 1 to 3 Docking Stations.

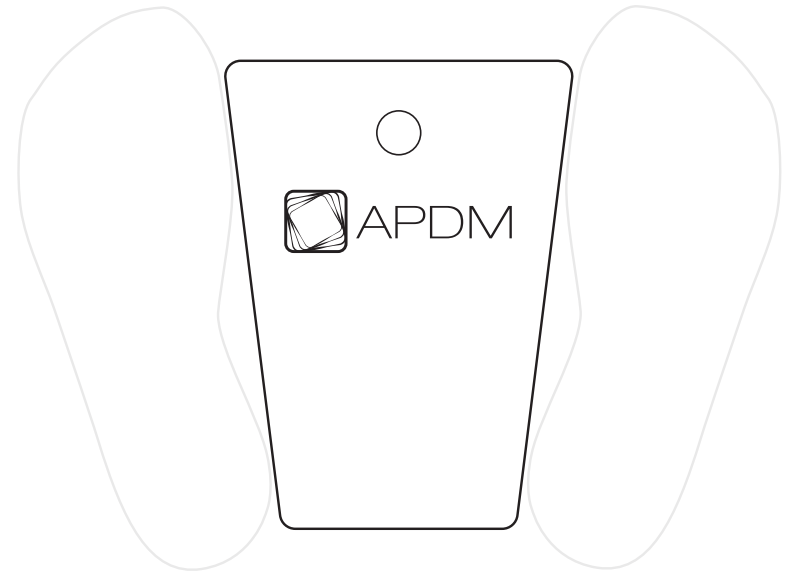
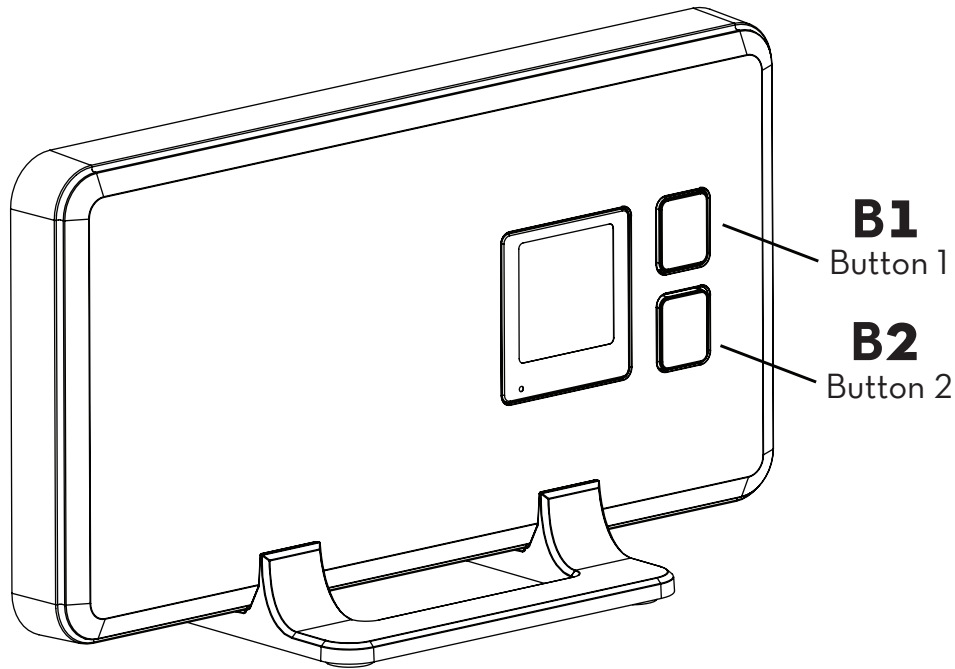

ACCESS POINT

The wireless Access Point allows for wireless communication between your computer and the Opal movement sensors. A single Access Point can support up to 6 Opals at 128Hz sampling rate (maximum of 1,600 samples per second per access point). Depending on your Package, you may have 1 to 3 Access Points.

FOOT PLATE

The Mobility Lab Footplate is designed to standardize stance width before each Mobility Lab test, unless otherwise noted.

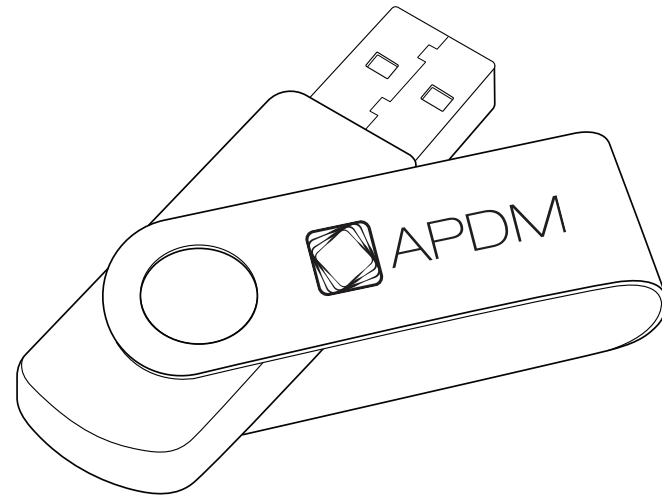
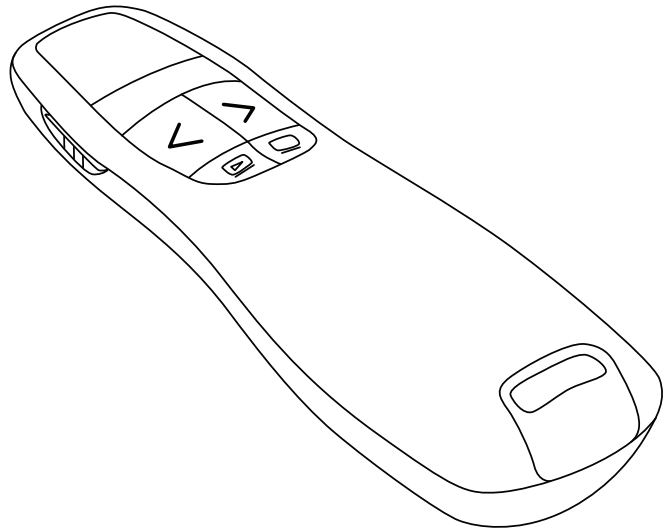

WIRELESS REMOTE

The Moveo Explorer software supports the use of a remote control to aid while collecting data.

USB DRIVE

The USB drive contains the Moveo Explorer software.



A

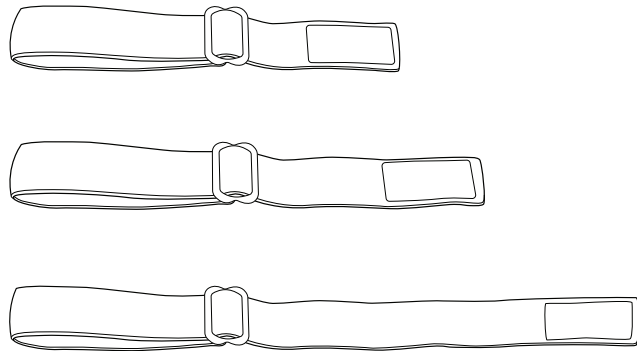

B

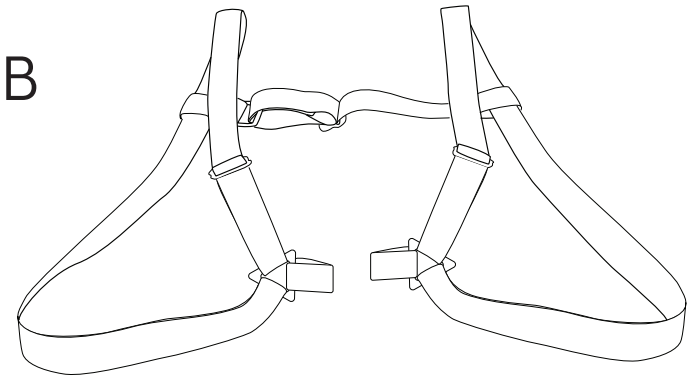

C

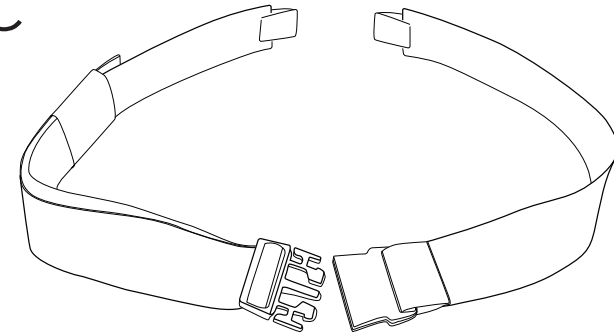

STRAPS

There are a number of options for securing the sensors on subjects using a selection of straps.*

A. Multi-length straps are suitable for universal use including hand, wrist, upper arm, head, upper leg, lower leg, and foot.

B. Sternum strap

C. Lumbar strap

*All straps are latex-free.



Sensor Placement

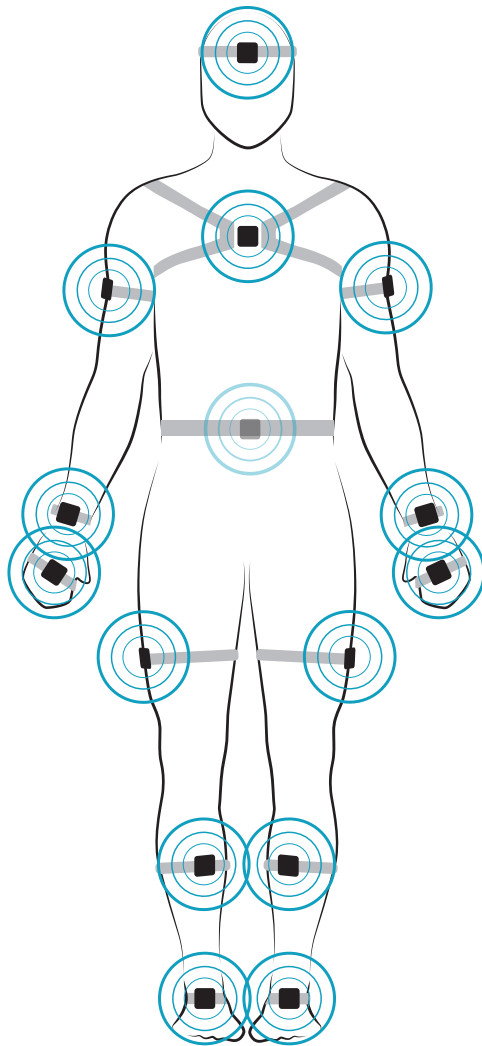

Foot

Centered on top of the foot

Lower Leg

Inside the front of the shin, on the flat surface of the bone, high enough for the strap to wrap just above the widest part of the calf muscle

Upper Leg

Side of thigh, midline, between muscular tissue, one hand's width above the knee

Lumbar

Centered on the low back, at the base of the spine

Sternum

Centered on the flat surface of the chest just below where the collar bones meet

Head

Centered on the front of the forehead

Upper Arm

Centered on the outside of the arm, just below the shoulder muscle

Wrist

On the wrist worn like a watch

Hand

On the back of the hand

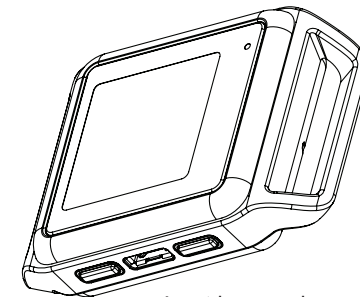

Always place the Opal port-side down

Your Moveo Explorer system may come with a complete or partial set of the sensors shown. For high impact or long duration activities, we recommend reinforcing strap/sensor placement with double sided skin-safe adhesive or additional wraps.

To upgrade your system, contact us at +1 503-445-7757 or sales@apdm.com.

HARDWARE SETUP



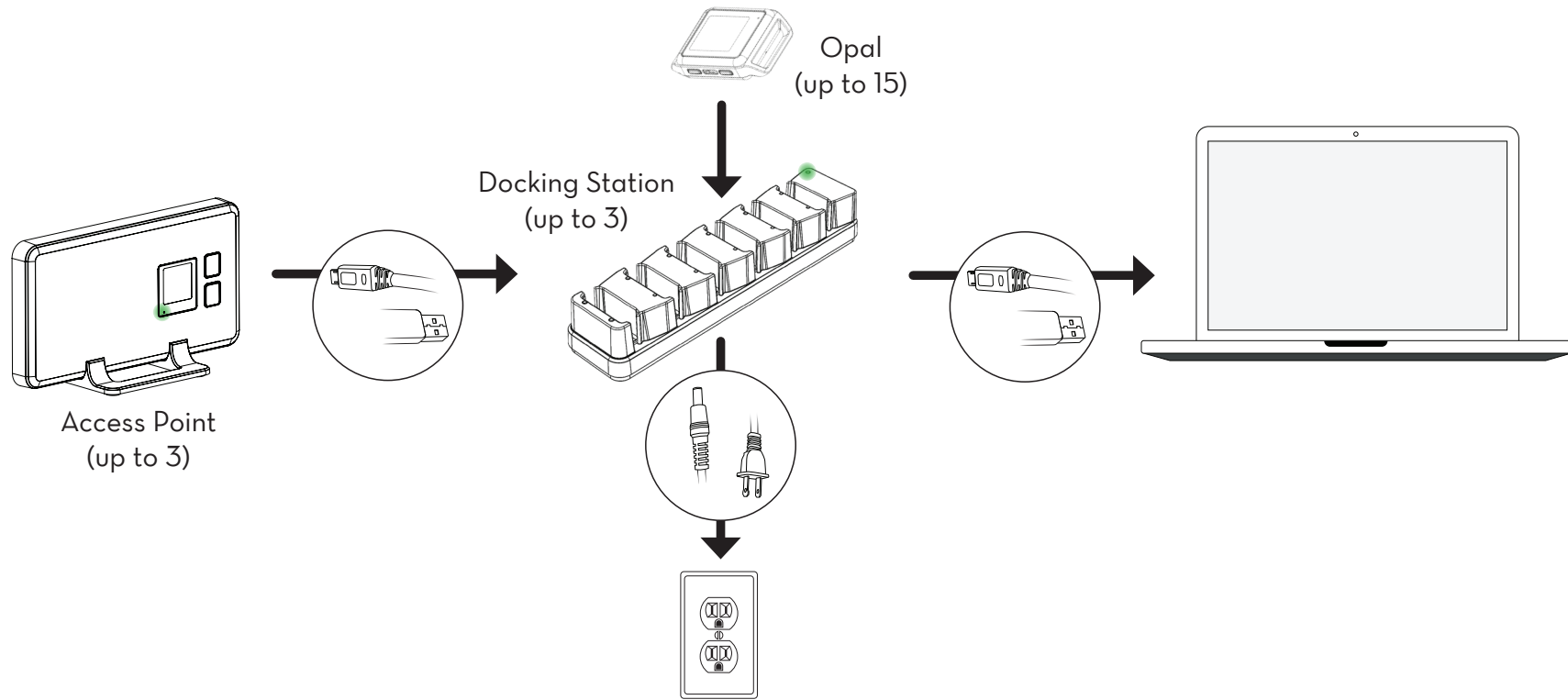

SETUP

1. Connect the Access Point(s) to the Docking Station(s) using a Micro USB cable.
2. Connect the external power adapter to the Docking Station(s), and plug it in to a power outlet.
3. Connect the Docking Station(s) to your computer using a Micro USB cable*.
4. Plug the Opal(s) into the Docking Station in any order.

* There are 1 dock and AP for every 6 Opals in your system. If needed, a USB hub will be provided.

It is the responsibility of the user to use the accessories supplied with the equipment.
Changes or modifications not expressly approved by APDM could void user's warranty.

MOVED EXPLORER INSTALLATION





Requirements

Operating System

Windows 7 (64-bit) or later.

(Make sure you have Internet Explorer 10 or later installed.)

OS X El Capitan (10.11) or later.

RAM

4GB+

Processor

Intel Core i3 or equivalent required.

Intel Core i5 or i7 recommended.

Drive Space

500MB for installation.

Recommended 100GB+ for ample recording storage.

Installation

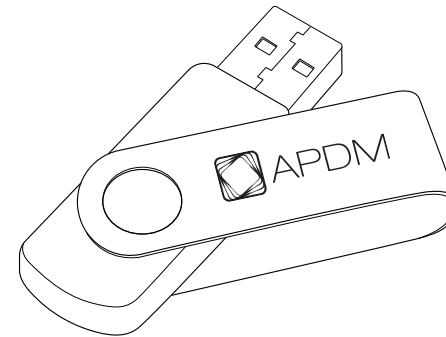

MacOS

- Insert the provided USB drive into your computer. Drag the Moveo Explorer icon into the Applications folder to install. Right click the Moveo Icon in your Applications folder and select “Open.” If you receive a security warning, right click and select “Open” a second time to launch the application. This behavior is dependent on the version of MacOS you are running and your specified security preferences.

Windows

- Insert the provided USB drive into your computer. Double click on the setup file. This will guide you through the installation process.

USING YOUR SYSTEM





Subjects

Filter

Subject ID	Last name	First name	Date of birth	First visit	Last visit	# of visits
001	Last Name	First Name	1970-01-01	--	--	0
002	Last Name	First Name	1970-01-01	--	--	0
003	Last Name	First Name	1970-01-01	--	--	0

MENU

1. **Subjects**

The Subjects tab shows all of the subjects in your Moveo Explorer system for a selected subject group.

2. **Options**

The Options tab shows all of the display options in your Moveo Explorer system for a selected subject group.

3. **Hardware Configuration**

The Hardware Configuration tab shows assigned sensor locations on the body.

4. **Power Off Sensors**

The Power Off Sensors tab turns off any docked sensors. Sensors will power off once undocked.

5. **Subject Group Selection**

The Subject Group Selection dropdown allows you to select, add, edit, delete, and export data for a specific subject group or study.

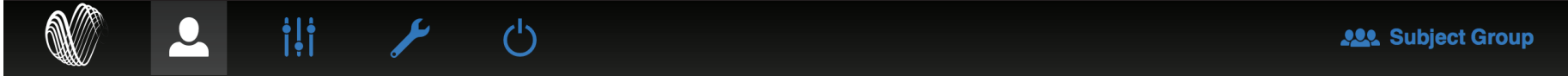

Subjects

Filter

[+ New Subject](#)

Subject ID	Last name	First name	Date of birth	First visit	Last visit	# of visits
001	Last Name	First Name	1970-01-01	--	--	0
002	Last Name	First Name	1970-01-01	--	--	0
003	Last Name	First Name	1970-01-01	--	--	0

SUBJECTS

The Subjects tab shows all of the test subjects in your Moveo Explorer system for a selected subject group.

Adding a Subject

Click on the “New Subject” button on the top right of your screen. Fill in the required fields and click Save. Note that you can change field requirements under the options tab.

Running a Test

Click on the subject you wish to test. Click on the “New Test” button on the top right of your screen.

Finishing a Test Sequence

Click on the subject you wish to test. Click on the red “bell” icon to the right of an unfinished test sequence. This option will be active for 24 hours after the sequence is started.



Options Demo

Metric Groups **Tests and Conditions** **Test Sequences** **Display Options**

Select metric group: Default Delete i + Add

Free Form **Walk** TUG Sway 360 Degree Turn Sit to Stand SAW

In addition to the metrics displayed on this page that can be selected for reporting, this test type also supports the estimation of joint angles continuously throughout the entire recording:

- The joint angles available will be dependent on which sensors are used and where they are placed on the subject
- The joint angles can be plotted from within the report
- The joint angles can be exported to either HDF or CSV format for further analysis

Duration

Lower Limb [Select All](#) [Deselect](#)

- Cadence
- Gait Cycle Duration
- Gait Speed
- Double Support
- Terminal Double Support
- Elevation at Midswing
- Lateral Step Variability
- Circumduction
- Foot Strike Angle

Turns [Select All](#) [Deselect](#)

- Angle
- Duration
- Turn Velocity
- Steps in Turn

Anticipatory Postural Adjustment [Select All](#) [Deselect](#)

- APA Duration
- First Step Duration

OPTIONS

The Options tab shows all of the display options in your Moveo Explorer system for a selected subject group.

Metric Groups

The “Metric Groups” page allows you to change which metrics are displayed in the test results window, and add custom metric groups for each test.

Tests and Conditions

The “Tests and Conditions” page allows you to add, edit, and delete custom tests and test conditions.

Test Sequences

The “Test Sequences” page allows you to add, edit, and delete custom test sequences.

Display Options

The “UI Options” page allows you to enable recording annotations, and allow configuration for logging.



Hardware Configuration

Available Sensors

Assigned Sensors

- XI-001110: Lumbar
- XI-001322: Right Foot
- XI-001333: Left Foot
- XI-001296: Right Wrist
- XI-001223: Sternum
- XI-001323: Left Wrist
- XI-001093: Forehead

Drag and drop sensors to place.

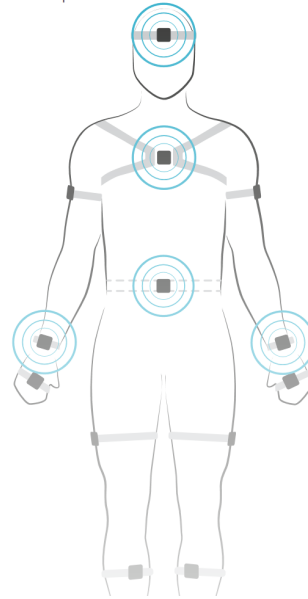

Wireless Channel: 30

Recording Mode: Streaming

Apply Configuration

Re-scan Hardware

Custom Sensor Assignments

	Sensor	Display Label
Custom #1	Custom 1	
Custom #2	Custom 2	
Custom #3	Custom 3	

HARDWARE CONFIGURATION

Assigning Sensors

Assign Opals to a body site location by dragging from the Available Sensors list and dropping on the human model. The sensors will now show in the Assigned Sensors list.

Custom Sensor Assignments

You can also assign custom sensor locations by typing in the Custom Sensor Assignment fields.

Apply Configuration

Click here when you are done choosing your configuration options. Make sure that sensors with specific straps are assigned to the correct location. You can use the ID on the back of the Opal to assist with this.

Recording Mode

If logging was allowed under Options/UI, select Streaming or Logging Recording Mode. Logging begins when the Opals are undocked.

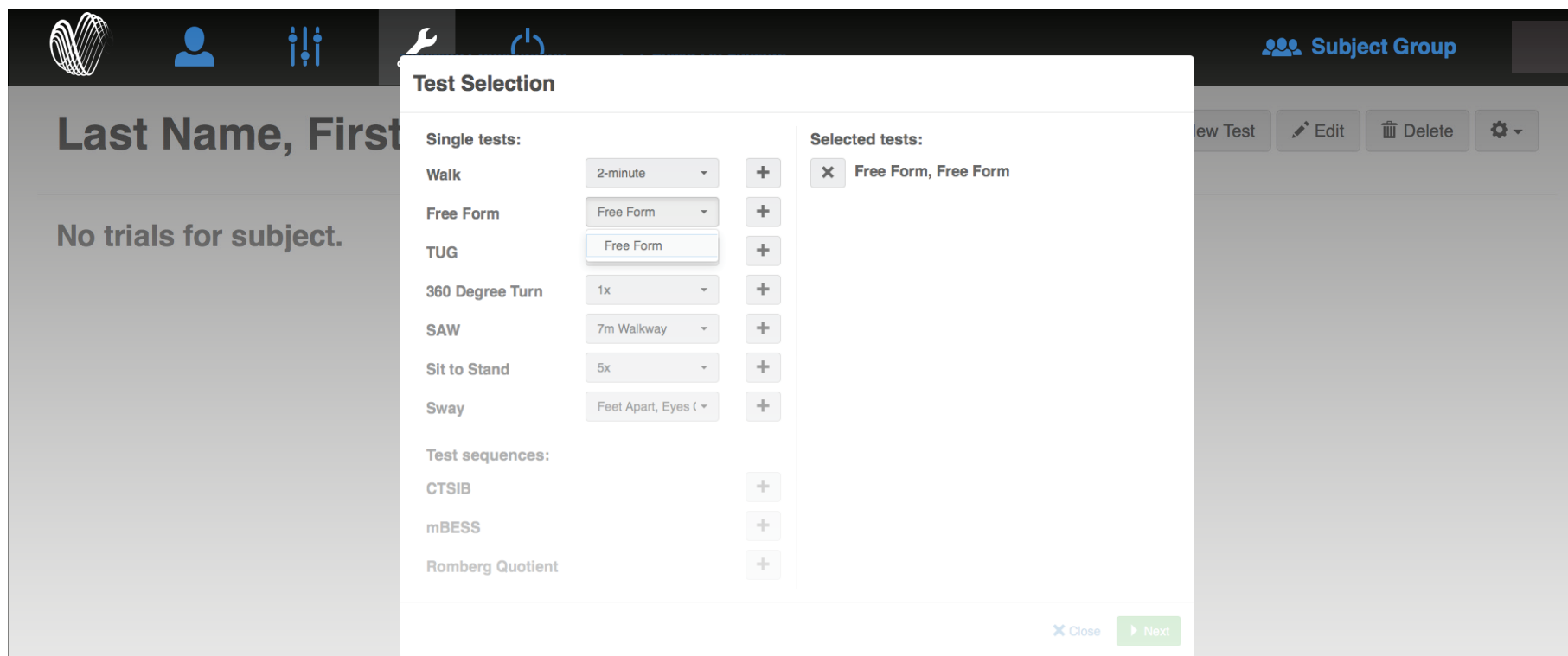

RUNNING A TEST

1. Click on the subject you wish to test. Click on the “New Test” button on the top right of your screen.
2. Select the test(s) and condition(s) you would like to run. You may select multiple tests or one predefined test sequence. Click Next to continue.
3. Follow the instructions on each dialog box to complete each test. Click on blue text for more instructions, including how to place sensors. Click Next.
4. Follow joint angle calibration instructions if collecting joint angle data. Subject instructions should be read out loud, and Administrator instructions should be referred to for more information.
5. If annotations were enabled under Options/UI, enter label(s) for the annotation buttons
6. If using the wireless remote, press the forward button to start and stop each test.

Tip: Your subject should remain still during the 3 second countdown at the beginning of the tests for proper calibration.

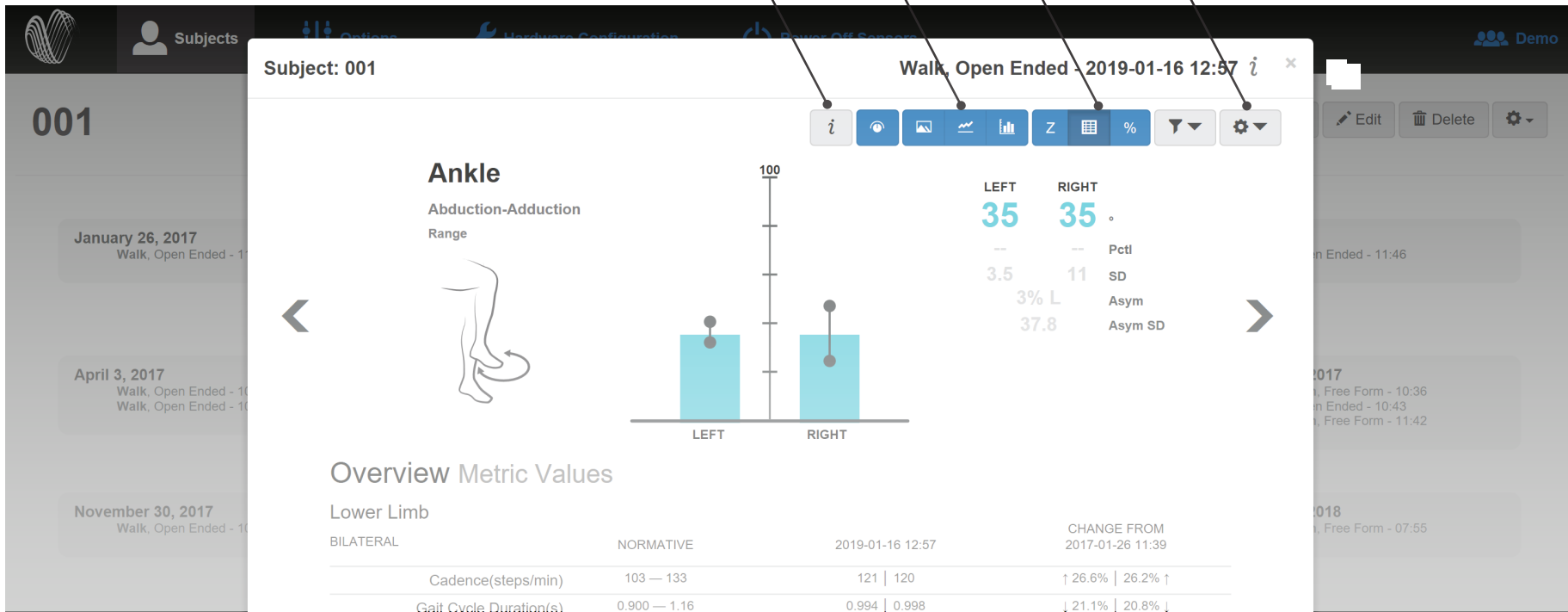

TEST RESULTS WINDOW

1. Information Key

The Information Key shows definitions for each metric, and information on how to read each graph.

2. Visualization Options

The Visualization Options show the data graph in different formats for a selected test, including detail view, drill-down, and longitudinal views with option to Filter by condition, sequence or day.

3. Report Table Options

The Report Table Options include Z-Score, Metric Values and Percentiles.

4. Tools Dropdown

The Tools Dropdown allows you to edit displayed metrics, access print view, export trial data, delete a test, and more.

Norms (shown in grey) are collected progressively from third party institutions. For more information, visit support.apdm.com.



Tests



The Moveo Explorer system comes equipped with multiple tests from published scientific studies. The table below indicates what each test can measure, and how many Opal sensors are necessary to run each test.

	Published Outcome Measures	Opals
F	Free movement	2+
W	Gait, Asymmetry, Variability and Turning, Joint range of motion	4+
T	Postural transitions (sit, stand, and turning)	3+
S	Postural sway	1+
C	Postural sway, Visual dependence, Proprioceptive dependence, and Vestibular loss	1+
mB	Postural stability in varying conditions	1+
360	Turn velocity, Turn time	1+
sS	Trunk excursion, Stand time, Cadence, Total time	1+
Sw	Gait, Asymmetry, Variability, Turning, and Postural Stability	3+



Gait Definitions

Lower Limb

Cadence	The number of steps per minute, counting steps made by both feet
Gait Cycle Duration	The duration of a full gait cycle, measured from the left foot's initial contact to the next initial contact of the left foot
Gait Speed	The forward speed of the subject, measured as the forward distance traveled during the gait cycle divided by the gait cycle duration
Foot Clearance	The height of the foot sensor measured at midswing, relative to its start position while standing
Double Support	The percentage of the gait cycle in which both feet are on the ground
Lateral Step Variability	In a series of 3 consecutive foot placements of the same foot, the variability of perpendicular deviations of the middle foot placement from the line connecting the first and third
Circumduction	The amount that the foot travels perpendicular to forward movement while swinging forward during an individual stride
Foot Strike Angle	The angle of the foot at the point of initial contact. The pitch of the foot when flat is zero and positive when the heel contacts first.
Toe Off Angle	The angle of the foot as it leaves the floor at push-off. The pitch of the foot when flat is zero.
Stance	The percentage of the gait cycle in which the foot is on the ground
Step Duration	The duration of a step, measured as the period from initial contact of one foot to the next initial contact of the opposite foot
Stride Length	The forward distance travelled by a foot during a gait cycle
Swing	The percentage of the gait cycle in which the foot is not on the ground
Toe Out Angle	The lateral angle of the foot during the stance phase, relative to the forward motion of the gait cycle. Positive angle is outward rotation.

Upper Limb

Arm Swing Velocity	The maximum rotational velocity of the arm swing
Arm Swing Range of Motion	The angular range of the arm swing

Trunk Range of Motion

Coronal	The angular range of the thoracic spine in the coronal plane (roll)
Sagittal	The angular range of the thoracic spine in the sagittal plane (pitch)
Transverse	The angular range of the thoracic spine in the transverse plane (yaw)

Lumbar Range of Motion

Coronal	The angular range of the lumbar spine in the coronal plane (roll)
Sagittal	The angular range of the lumbar spine in the sagittal plane (pitch)
Transverse	The angular range of the lumbar spine in the transverse plane (yaw)

Sit To Stand

Duration	The duration of the sit to stand transition
Lean Angle	The angular range of motion of the trunk during the sit to stand transition

Turning

Angle	The rotational angle of the turn
Duration	The duration of the turn
Velocity	The peak angular velocity of the turn



Each test within the Moveo Explorer system is designed to capture data for certain metrics. The table below indicates the metrics each test captures, and which system (Lower Limb, Upper Limb, or Full Body) is necessary to gather data for each metric.

Lower Limb	Lower Limb	Upper Limb	Full Body
Cadence	✓		✓
Gait Cycle Duration	✓		✓
Gait Speed	✓		✓
Elevation at Midswing	✓		✓
Double Support	✓		✓
Lateral Step Variability	✓		✓
Circumduction	✓		✓
Foot Strike Angle	✓		✓
Toe Off Angle	✓		✓
Stance	✓		✓
Step Duration	✓		✓
Stride Length	✓		✓
Swing	✓		✓
Toe Out Angle	✓		✓
Upper Limb			
Maximum Velocity		✓	✓
Range of Motion		✓	✓



Trunk Range of Motion	Lower Limb	Upper Body	Full Body
Coronal		✓	✓
Sagittal		✓	✓
Transverse		✓	✓
Lumbar Range of Motion			
Coronal	✓		✓
Sagittal	✓		✓
Transverse	✓		✓
Sit To Stand			
Duration	✓	✓	✓
Lean Angle		✓	✓
Stand To Sit			
Duration	✓	✓	✓
Lean Angle		✓	✓
Turning			
Angle	✓		✓
Duration	✓		✓
Velocity	✓		✓
Steps in Turn	✓		✓



Anticipatory Postural Adjustment	Lower Limb	Upper Body	Full Body
Duration	✓		✓
First Step Duration	✓		✓
First Step Range of Motion	✓		✓
Sagittal Max Acceleration	✓		✓
Coronal Max Acceleration	✓		✓
Postural Sway			
Duration	✓		✓
Sway Area	✓		✓
95% Ellipse Sway Area	✓		✓
RMS Sway	✓		✓
Coronal RMS Sway	✓		✓
Sagittal RMS Sway	✓		✓
Centroidal Frequency	✓		✓
Centroidal Frequency (Coronal)	✓		✓
Centroidal Frequency (Sagittal)	✓		✓
Frequency Dispersion	✓		✓
Frequency Dispersion (Coronal)	✓		✓
Frequency Dispersion (Sagittal)	✓		✓
Jerk	✓		✓
Jerk (Coronal)	✓		✓
Jerk (Sagittal)	✓		✓



	Lower Limb	Upper Body	Full Body
Mean Velocity	✓		✓
Mean Velocity (Coronal)	✓		✓
Mean Velocity (Sagittal)	✓		✓
Path Length	✓		✓
Path Length (Coronal)	✓		✓
Path Length (Sagittal)	✓		✓
Range	✓		✓
Range (Coronal)	✓		✓
Range (Sagittal)	✓		✓
Neck Range of Motion			
R-L Bend Max.		✓	✓
R-L Bend Min.		✓	✓
R-L Bend Range		✓	✓
Flexion-Extension Max.		✓	✓
Flexion-Extension Min.		✓	✓
Flexion-Extension Range		✓	✓
R-L Rotation Max.		✓	✓
R-L Rotation Min.		✓	✓
R-L Rotation Range		✓	✓



Back Range of Motion	Lower Limb	Upper Body	Full Body
R-L Bend Max.			✓
R-L Bend Min.			✓
R-L Bend Range			✓
Flexion-Extension Max.			✓
Flexion-Extension Min.			✓
Flexion-Extension Range			✓
I-E Rotation Max.			✓
I-E Rotation Min.			✓
I-E Rotation Range			✓
Shoulder Range of Motion			
Abd-Add Max.		✓	✓
Abd-Add Min.		✓	✓
Abd-Add Range		✓	✓
Flexion-Extension Max.		✓	✓
Flexion-Extension Min.		✓	✓
Flexion-Extension Range		✓	✓
I-E Rotation Max.		✓	✓
I-E Rotation Min.		✓	✓
I-E Rotation Range		✓	✓



Elbow Range of Motion	Lower Limb	Upper Body	Full Body
Flex-Ext Max.		✓	✓
Flex-Ext Min.		✓	✓
Flex-Ext Range		✓	✓
Sup-Pro Max.		✓	✓
Sup-Pro Min.		✓	✓
Sup-Pro Range		✓	✓
Wrist Range of Motion			
Uln-Rad Max.		✓	✓
Uln-Rad Min.		✓	✓
Uln-Rad Range		✓	✓
Flex-Ext Max.		✓	✓
Flex-Ext Min.		✓	✓
Flex-Ext Range		✓	✓
Hip Range of Motion			
Abd-Add Max.	✓		✓
Abd-Add Min.	✓		✓
Abd-Add Range	✓		✓
Flexion-Extension Max.	✓		✓
Flexion-Extension Min.	✓		✓
Flexion-Extension Range	✓		✓
I-E Rotation Max.	✓		✓
I-E Rotation Min.	✓		✓
I-E Rotation Range	✓		✓



Knee Range of Motion	Lower Limb	Upper Body	Full Body
Var-Val Max.	✓		✓
Var-Val Min.	✓		✓
Var-Val Range	✓		✓
Flexion-Extension Max.	✓		✓
Flexion-Extension Min.	✓		✓
Flexion-Extension Range	✓		✓
I-E Rotation Max.	✓		✓
I-E Rotation Min.	✓		✓
I-E Rotation Range	✓		✓
Ankle Range of Motion			
Inv-Eve Max.	✓		✓
Inv-Eve Min.	✓		✓
Inv-Eve Range	✓		✓
Dor-Plantar Max.	✓		✓
Dor-Plantar Min.	✓		✓
Dor-Plantar Range	✓		✓
I-E Rotation Max.	✓		✓
I-E Rotation Min.	✓		✓
I-E Rotation Range	✓		✓

To upgrade your APDM sensor system, contact us at 888-988-APDM (2736) or info@apdm.com.



Opal Screen Interface

The screen interface on the Opal Sensors provides important information about the registration and operating state of the hardware. The table below shows the navigation to different screens on the interface. Navigation of these screens is not required to complete a test.

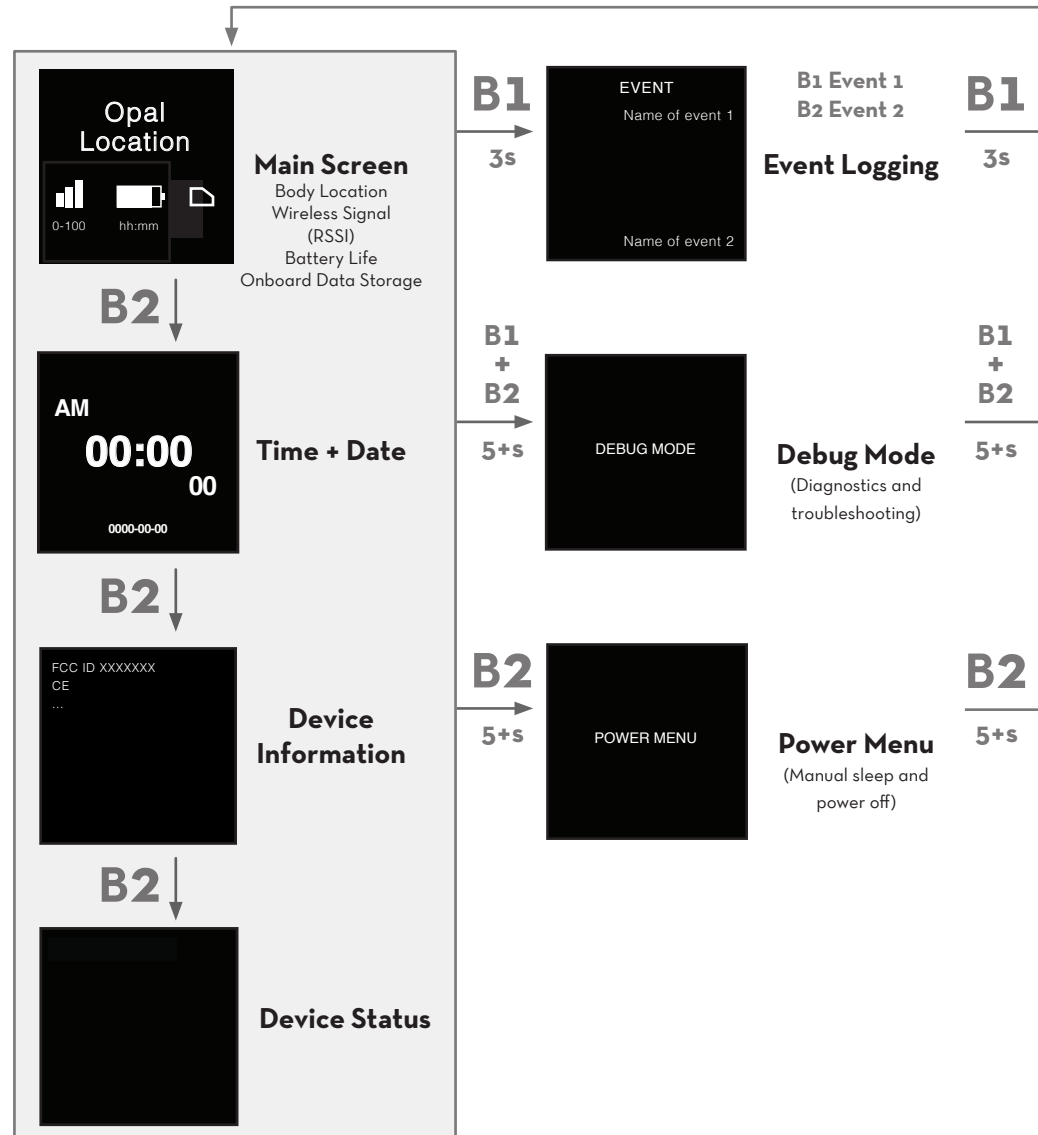



Access Point Screen Interface

The screen interface on the Access Point provides important information about the registration and operating state of the hardware. The table below shows the navigation to different screens on the interface.

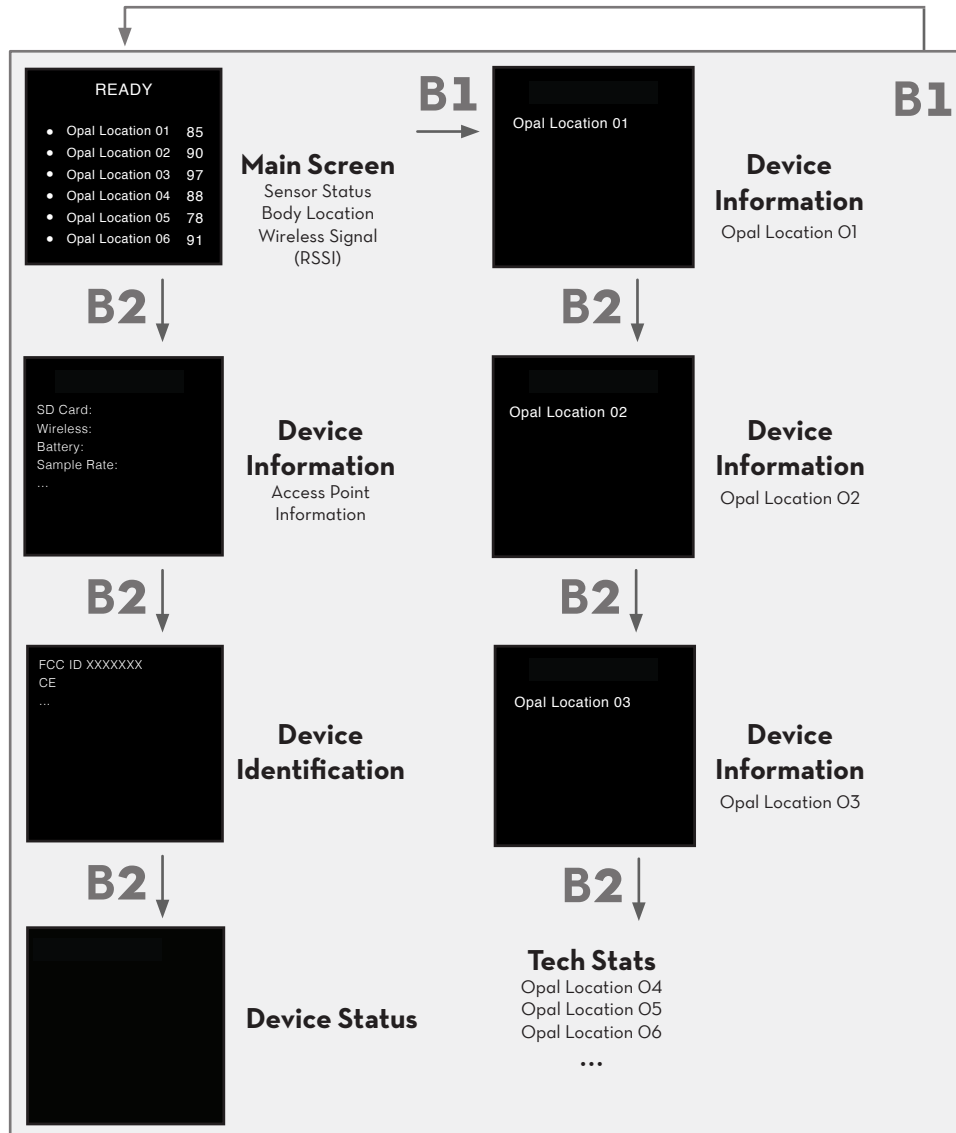

The Status screen on the AP indicates if the Opal sensors are ready to record data. Symbols on the left-hand side of the screen identify the following:

- Opal is ready to stream data
- ✗ Communicating with the Opal wirelessly, but not yet ready to stream data.
- ! Not receiving data from the Opal. The Opal may be docked or out of range.

TIPS





Storage

In daily use situations, it is sufficient to simply dock your sensors when not in use. When docked, sensors stop recording, stop broadcasting, and charge batteries.

For periodic users, it is best to power off all system components for storage and transport. This can be done by docking the sensors and clicking the “Power Off” button in the Moveo Explorer menu. The sensors will power down the next time they are undocked.

Cleaning

As the Opal wearable sensors come in direct contact with subjects, they should be cleaned after every use. To clean the Opal use a low-level disinfectant on a soft, lint-free cloth. Examples of low-level disinfectants include 70% or greater isopropyl alcohol, 10% bleach solution, or various commercial disinfectant wipes. Do not immerse in or spray the Opals with a liquid. Do not use abrasive cleaners.

The Access Point, Docking Station, and all associated cabling do not require cleaning. If you wish to clean these, please use a mild cleaning solution on a soft, lint-free cloth. Do not immerse in or spray the Access Point or Docking Station with a liquid. Do not use abrasive cleaners. The sensor straps can be removed and washed separately using mild soap and water.

Subject Attire

The subject should wear clothing that does not bind their movement in any significant way. Walking shoes should be worn (i.e. no heels or flip-flops). If walking shoes are unavailable, it is preferable that the subject walk barefoot.

TROUBLESHOOTING

APDM is pleased to assist you with any questions you may have about your hardware, software, or the use of the technology in your study.

Please contact us at:
web: support.apdm.com





















LED Patterns and Error Messages

The LED on the system hardware provides important information about the operating state of the hardware. The table below lists the LED flashing patterns associated with these states, which can be useful in troubleshooting issues encountered with the hardware.

LED Colors

-  White
-  Red
-  Yellow
-  Green
-  Blue

	Pattern	State
		Solid white - Startup
Docked Opal		Solid blue - charge is >90%
		Blue, green every 2s - charge is >30% and <90%
		Blue, green every 1s - charge is <30%
Undocked Opal	 brief	Green every 2s - Opal is transmitting data, <5s of latency
	 long	Green every 2s - Opal is transmitting data, >5s of latency
		Solid green - Opal has not transmitted any data in >5s
		Battery is <10%
		Error
Access Point	 brief	Green every 2s - latency is <5s
	 long	Green every 2s - latency is >5s
		Solid green - AP has not received data from at least 1 Opal in >5s
		Error
Docking Station		Solid Green (Dock body front) - Power on
		Green (Opal slot) - Opal has been detected by computer
		Solid Green (Dock body back) - USB port device detected by computer

SPECIFICATIONS



For complete sensor information, please visit www.apdm.com

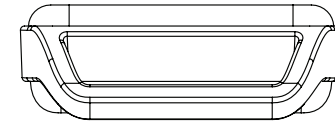
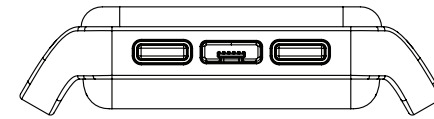
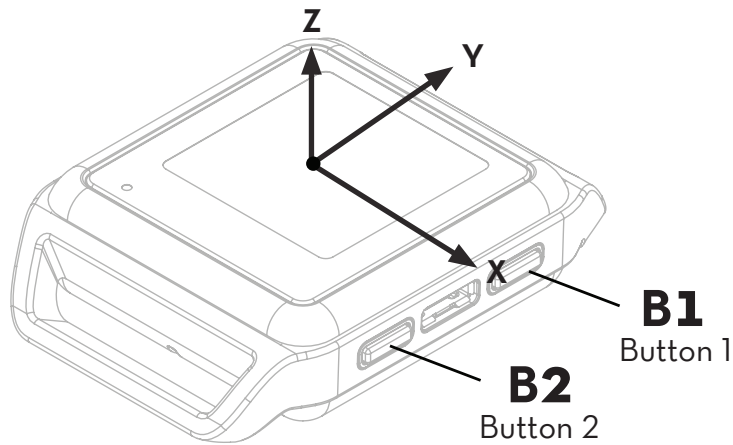

Dimensions	54.9 x 40.0 x 14.3 mm
Material	Polycarbonate, glass
Weight	<25 grams (with battery)
Battery Life	Wireless Streaming (8h), Synchronous Logging (12h), Asynchronous Logging (16h)
Wireless Radio	Nordic Semiconductor nRF51822
Frequency Band	2.40-2.48GHz ISM band, adjustable
Data Rate	2Mbps on-air data-rate
Latency	300ms (typical) with data buffer, 30ms (typical) without data buffer
Transmission Range	30m line of sight, 10m indoors
Data Buffer	8Gb (~450 hours)
Synchronization	≤1ms difference, up to 24 Opals
Screen Resolution	128px x 128px

APPENDIX





EMC Declarations

The Opal Wearable Sensor, Docking Station, and Access Point (“Opal System hardware”) must be installed and put into service according to the electromagnetic compliance (EMC) guidelines and declarations provided here.

EMC Declarations and Guidance

Table A-1	Electromagnetic emissions
Table A-2	Electromagnetic immunity
Table A-3	Electromagnetic immunity for non-life-supporting equipment
Table A-4	Recommended separation distances between radio-frequency (RF) communications equipment for non-life-supporting equipment

Note: Portable and mobile RF communications equipment can affect the operation of the Opal System hardware.

Warning: The use of accessories and cables other than those provided by APDM may result in increased emissions or decreased immunity of the Opal System hardware.



Table A-1: Guidance and Manufacturer’s Declarations - Electromagnetic Emissions

The Opal System is intended for use in the electromagnetic environment specified below. The customer or user of the Opal System should ensure that they are used in such an environment.

Emissions Test	Compliance	Electromagnetic Environment - Guidance
RF Emissions	CISPR 11	Group 1 The Opal System uses very low level RF energy and are not likely to cause any interference in nearby electronic equipment.
RF Emissions	CISPR 11	Class B The Opal System is suitable for use in all establishments, including domestic establishments and those directly connected to the public low voltage power supply network that supplies buildings used for domestic purposes.
Harmonic Current Emissions IEC 61000-3-2	Class B	
Voltage Fluctuations and Flicker IEC 61000-3-3	Complies	



Table A-2: Guidance and Manufacturer’s Declaration - Electromagnetic Immunity

The Opal System is intended for use in the electromagnetic environment specified below. The customer or user of the Opal System should assure that it is used in such an environment.

Immunity Test	IEC 60601 Test Level	Compliance	Electromagnetic Environment - Guidance
Electrostatic Discharge (ESD) IEC 61000-4-2	± 8 kV contact ± 15 kV air	± 8 kV contact ± 15 kV air	Floors should be wood, concrete, or ceramic tile. If floors are covered with synthetic material, the relative humidity should be at least 30%.
Electrical Fast Transients and Bursts (EFT) IEC 61000-4-4	± 2kV for power supply lines	± 2kV for power supply lines	The mains power quality should be that of a typical commercial or hospital environment.
Surge IEC 61000-4-5	± 2kV differential mode ± 2 kV common mode	± 2kV differential mode ± 2 kV common mode	The mains power quality should be that of a typical commercial or hospital environment.
Voltage Dips and Interruptions IEC 61000-4-11	100% dip in 0.5 cycles 60% dip in 5 cycles 30% dip in 25/30 cycles 100% dip in 250/300 cycles	100% dip in 0.5 cycles 60% dip in 5 cycles 30% dip in 25/30 cycles 100% dip in 250/300 cycles	The mains power quality should be that of a typical commercial or hospital environment. If the user of the Opal System requires continued operation during a power mains interruption, it is recommended that the Opal System be powered from an uninterruptible power supply or battery.
Magnetic Field Immunity (50/60 Hz) IEC 61000-4-8	30 A/m	30 A/m	Power frequency magnetic fields should be at levels characteristic of a typical location a typical commercial or hospital environment.



Table A-3: Guidance and Manufacturer’s Declarations - Electromagnetic Immunity for Non-life-supporting Equipment

The Opal System is intended for use in the electromagnetic environment specified below. The customer or user of the Opal System should assure that it is used in such an environment.

Immunity Test	IEC 60601 Test Level	Compliance	Electromagnetic Environment - Guidance
			<p>Portable and mobile RF communications equipment should be used no closer to any part of the Opal System, including cables, than the recommended separation distance calculated from the equation applicable to the frequency of the transmitter.</p> <p>Recommended separation distance:</p>
Conducted Immunity IEC 61000-4-6	≥ 6 VRMS 150 kHz to 80 MHz	3 VRMS	$d = 1.2\sqrt{P}$
Radiated Immunity IEC 61000-4-3:2010	≥ 10 V/m 80 MHz to 2700 MHz	10 V/m	$d = 1.2\sqrt{P}$ 80 MHz to 800 MHz $d = 1.2\sqrt{P}$ 880 MHz to 2.5 GHz
			<p>Where P is the maximum output power rating of the transmitter in Watts according to the transmitter manufacturer and d is the recommended separation distance in meters.</p> <p>Field strengths from fixed RF transmitters, as determined by an electromagnetic site survey^a, should be less than the compliance level in each frequency range^b.</p> <p>Interference may occur in the vicinity of equipment marked with the following symbol:</p> 



Note 1 At 80 MHz and 800 MHz, the higher frequency range applies.

Note 2 These guidelines may not apply in all situations. Electromagnetic propagation is affected by absorption and reflection from structures, objects, and people.

- a** Field strengths from fixed transmitters, such as base stations for radio (cellular/cordless) telephones and land mobile radios, amateur radio, AM and FM radio broadcast and TV broadcast cannot be predicted theoretically with accuracy. To assess the electromagnetic environment due to fixed RF transmitters, an electromagnetic site survey should be considered. If the measured field strength in the location in which the Opal System is used exceeds the applicable RF compliance level above, the Opal System should be observed to verify normal operation. If abnormal performance is observed, additional measures may be necessary, such as reorienting or relocating the Opal System.
- b** Over the frequency range 150 kHz to 80 MHz, field strengths should be less than 10 V/m.



Table A-4: Recommended separation distances between portable and mobile RF communications equipment and the Opal System.

The Opal System is intended for use in an electromagnetic environment in which radiated RF disturbances are controlled. The customer or the user of the Opal System can help prevent electromagnetic interference by maintaining a minimum distance between portable and mobile RF communications equipment (transmitters) and the Opal System as recommended below, according to the maximum output power of the communications equipment.

Rated maximum output power (Watts) of transmitter	Separation distance (meters) according to frequency of transmitter		
	150 kHz to 80 MHz $d = 1.2\sqrt{P}$	80 MHz to 800 MHz $d = 1.2\sqrt{P}$	800 MHz to 2.5 GHz $d = 1.2\sqrt{P}$
0.01	0.12	0.12	0.23
0.1	0.38	0.38	0.73
1	1.2	1.2	2.3
10	3.8	3.8	7.3
100	12	12	23

For transmitters rated at a maximum output power not listed above, the recommended separation distance d in meters (m) can be estimated using the equation applicable to the frequency of the transmitter, where P is the maximum output power rating of the transmitter in Watts (W) according to the transmitter manufacturer.

Note 1 At 80 MHz and 800 MHz, the separation distance for the higher frequency range applies.

Note 2 These guidelines may not apply in all situations. Electromagnetic propagation is affected by absorption and reflection from structure, objects, and people.

CONTACT US

APDM, Inc.
WEARABLE TECHNOLOGIES

2828 SW Corbett Ave Suite 135
Portland, OR 97201

503.445.7757
apdm.com/kinematics

